

KeyRF

**KeyRF
PC Remote
Control
(Version 2.2N)**

Copyright 1998-2002
L3 Systems, Inc.
Redmond, WA

Table of Contents

Introduction	1
Notes of Caution	1
Antenna Assembly	2
KeyRF Components	2
Connections using PS/2 Interface	3
Connections using USB Interface	4
LED Status	5
KeyRF Default Setup	5
Running Setup	6
[B] Button Configuration	7
[A] Transmitter Address	9
Changing Transmitter Battery	9
[D] Restore Setup to Factory Settings	10
[C] View/Change Receiver Configuration	10
Disabling Combo Buttons	11
Two-Button Left→Right & Right→Left Operation	11
Enabling the Four-Button Shift Key	11
Multiple Transmitter Feature	12
Repeating Buttons	13
Using a PS/2 Y-Adapter	13
Pull Out Antenna for Better Range	14
KeyRF Mini-DIN Connectors	14
KeyRF Specifications	15
Warranty	Inside Back Page

Introduction

The KeyRF PC Remote Control Adapter provides a way to send remote control signals to your PC. Some of the advanced features of the KeyRF are:

- ◆ **Superior RF technology** – Receives 360° with better performance as compared to infrared type remotes.
- ◆ **Easy to use** – Remote fits easily in your palm, or your pocket. No pointing required. Just click wherever you are and it works!
- ◆ **Programmable Button Actions** – Different key sequences can be sent to the PC, based on the way the buttons are pressed on the remote transmitter.
- ◆ **Easy installation** – KeyRF requires no special software to be installed on your system. Just plug between your PC and keyboard and you are ready to go.
- ◆ **Fast!** – The KeyRF is responsive, making your presentation move along smoothly.

Notes of Caution

Before using the KeyRF PC remote Control, a few notes of caution should be considered.



Before connecting, or disconnecting the KeyRF, make sure power is turned off to your computer.



Do not discharge static electricity to antenna. Touch a grounded object first before contacting antenna. This can lock up or even damage the receiver.

Antenna Assembly

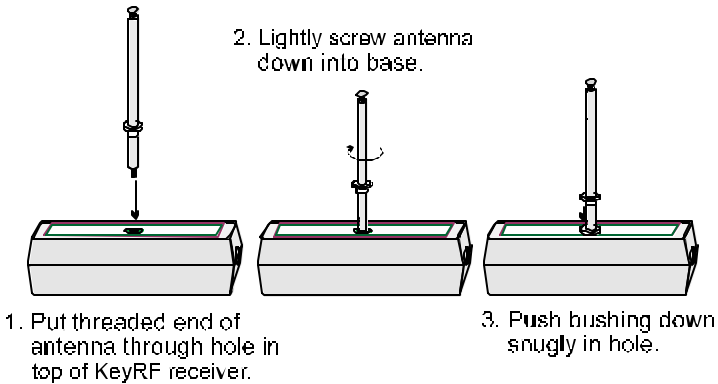

KeyRF Components

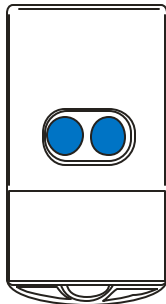

KeyRF 2-Bu

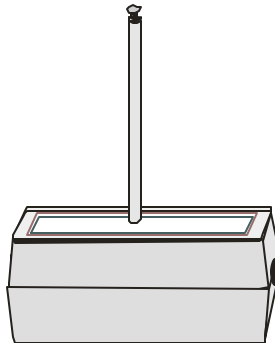

KeyRF Receiver

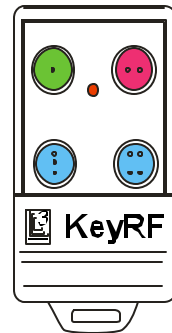

KeyRF 4-Bu

The two key components of a KeyRF system are the transmitter and receiver. The KeyRF is available with either a two-button or a four-button transmitter. When a transmitter button is pressed, it sends a radio frequency signal to the KeyRF receiver. The receiver then relays data to the computer which mimics keyboard key presses. The receiver comes pre-programmed with keystrokes assigned to the transmitter buttons that work well to advance slides for most presentation software. You can re-program what keystrokes are sent to the computer for each button, and that information will be stored in the receiver for use with any computer.

Connections Using PS/2 Interface

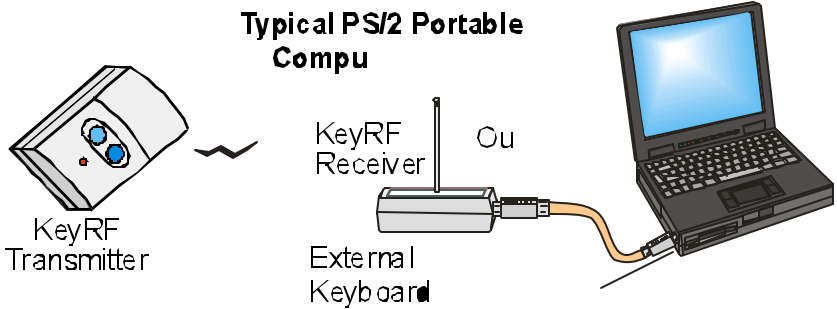
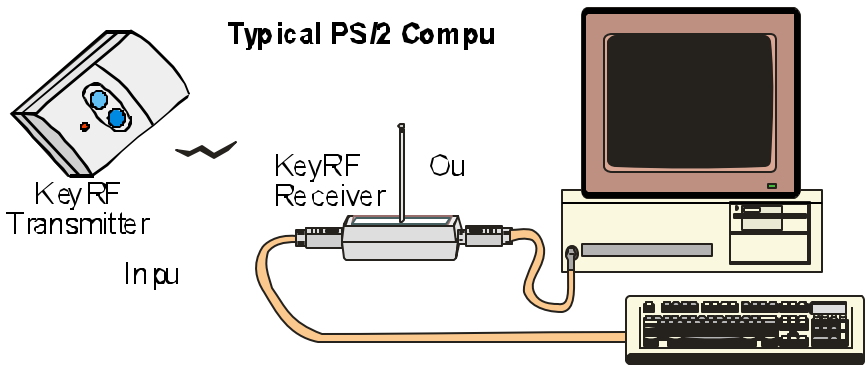

1. First, make sure the Computer/Laptop is turned off.
2. For a desktop computer, first unplug the keyboard from the computer.
3. Plug the one end of the supplied KeyRF cable into the desktop computer's keyboard port, or a Laptop's external mouse/keyboard port. *If your mouse does not have a 6-pin circular connector marked with a mouse or keyboard you may have to get a CL0014 PS/2 to USB adapter shown on the next page. If you have an IBM Thinkpad laptop, you may need a CL0012 PS/2 Y-adapter discussed later on in this manual.*
4. Plug the other end of the KeyRF cable to the "To Computer" connector on the KeyRF receiver.
5. If you have a desktop computer, or a laptop external keyboard, connect the keyboard to "To Keyboard" connector on the receiver.
6. Turn your computer on, and you're ready to go. If you are using presentation software, run a presentation in "show" mode and try advancing slides.

Connections Using USB Interface

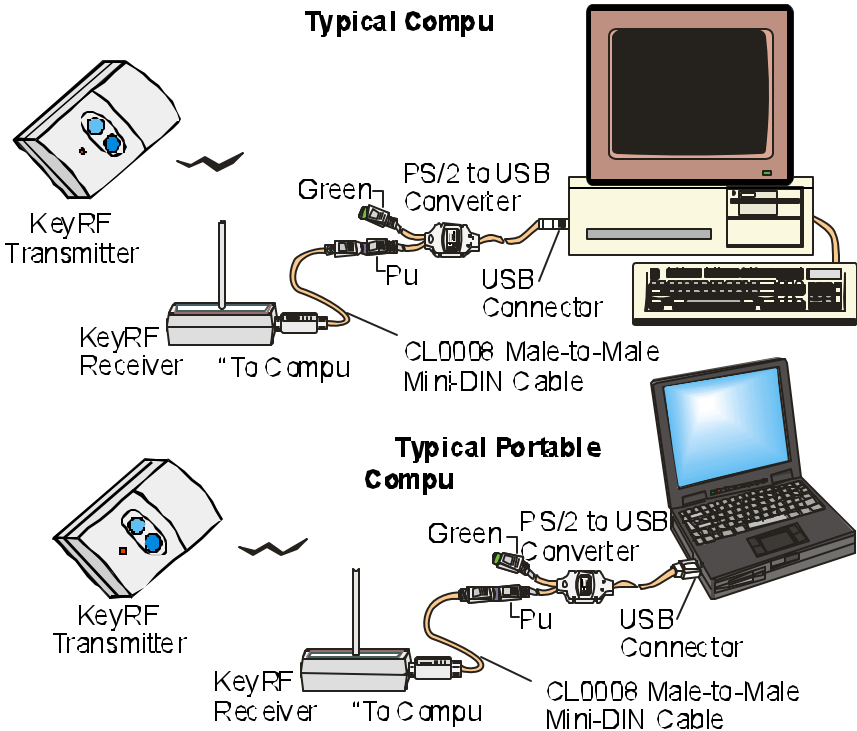

1. Turn your computer on.
2. Connect one end of the supplied Mini-DIN cable to the purple connector on the PS/2 to USB converter.
3. Connect the other end of the Mini-DIN cable to the "To Computer" connector on the KeyRF receiver;
4. Plug the USB connector into a USB receptacle on the computer.
5. You should notice the computer detecting the USB connection. It may ask you to press "OK" a few times. Windows 98 may prompt for you to put in the Windows disk for a driver. Once this is done, you should be ready to use the KeyRF. If you are using presentation software, run a presentation in "show" mode and try advancing slides.

LED Status

A red status indicator located next to the keyboard connector indicates both keyboard and remote control activity. It turns solid red when the attached keyboard is being used. It blinks red whenever the RF transmitter button is pressed.

KeyRF Default Setup

The KeyRF is shipped ready to use and set up as below.

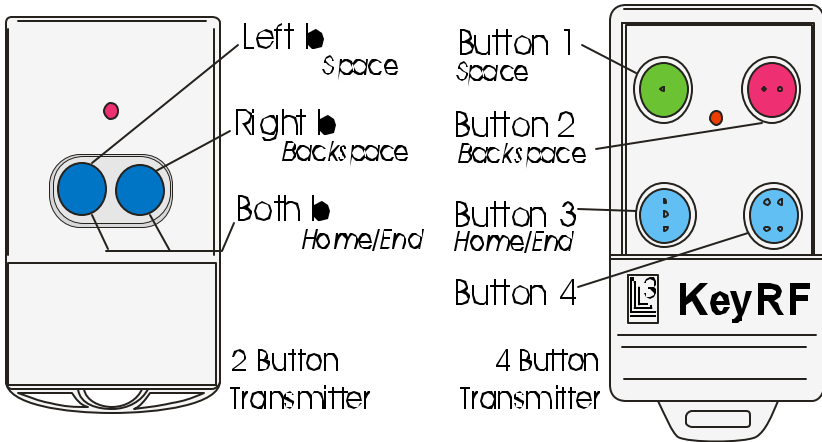

The default settings work well with overhead presentation programs. After connecting the KeyRF System (see previous two pages), just run your presentation software in “show” mode and use the left button or button 1 to advance your slides. Another easy way to test the KeyRF is to run your favorite editor or word processor application. When you press the left button, or button #1 it should print a space. The right button, or button #2 should do a backspace.

Running Setup

If the default settings do not fit your application, custom keys can be configured. To configure the Key RF, you must connect and use a PS/2 keyboard to the KeyRF Receiver.

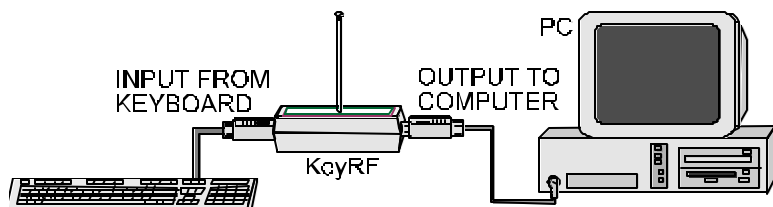

With the computer booted, make sure that you are in a text based "shell". On a DOS computer, that is the normal command prompt. On a Windows computer, bring up a DOS command shell. For Unix systems, bring up a login or Xterm shell. For MAC Systems, run the SimpleText editor.

On the PS/2 keyboard (not the laptop keyboard), alternate pressing Left-Shift, Right-Shift, Left-Shift, Right Shift, Left-Shift..., until the following prompt displays:

```
[B] Buttons [D] Default [A] Address [C] Config [Q] Quit
```

Now you can enter setup data. First, a quick summary:

- B - **Button settings** – Select this to change the keys configured for the transmitter buttons.
- D - **Default Settings** – Select this to return the KeyRF settings back to factory default.
- A - **Address** – Allows you to match the address of the transmitter. Usually this is only used when you have more than one KeyRF in the vicinity.
- C - **Configuration** – This is used to configure the transmitter. Just leave this alone.
- Q - **Quit** – Quit configuration.

[B] Button Configuration

If you press “B” in response to the initial setup prompt, the following will be displayed for a 2-button transmitter:

[L]Left [R]Right [B]Both [X]Lt->Rt [Y]Rt->Lt

The 4-button transmitter prompt:

[1][2][3][4] [5]4&1 [6]4&2 [7]4&3 [8]2&1 [9]3&1 [A]3&2

The following tables show what button actions are selected by the response to the prompt:

2-Button Transmitter	
Buffer # ← Buttons	
L	Left Button
R	Right Button
B	Both Buttons
X	Press Left, and while holding, press right.
Y	Press Right, and while holding, press left.

4-Button Transmitter			
Buffer # ← Buttons		Buffer # ← Buttons	
1	Button 1	6	Buttons 4 & 2
2	Button 2	7	Buttons 4 & 3
3	Button 3	8	Buttons 2 & 1
4	Button 4	9	Buttons 3 & 1
5	Buttons 4 & 1	A	Buttons 3 & 2

Note: Programming either the X or Y actions will affect the way the KeyRF 2- button remote works. If X and Y are not programmed (factory default), the Left and right buttons will cause the keystrokes to be sent to the PC upon pressing down the button. If X or Y are programmed, then keystrokes will not be sent until the button is released or after a short delay. You will notice this initial delay using auto-repeat. If you find you do not like this mode of operation, use the [D] command to revert to factory defaults.

After selecting the button, the following prompt will appear:

[S]Single or [A]Alternating

Now press S for “Single” unless you want the button to alternate between two actions. An example of alternating actions is the buffer B default that alternates between sending the “HOME” and “END” keys that directs the presentation program to go to either the beginning or end of the slide sequence.

If “S” for single is selected, the following prompt appears:

Press key(s), end with Right-SHIFT key:

KeyRF - PC Remote Control

At this point type the keys you wish to program for the button. (*Note that the keys will not echo as you type. This is to avoid undesired consequences of displaying special keys such as function keys.*) Generally for a single button, about 10 keystrokes can be stored. Some keys require more memory storage, so this will vary. If you type too many keys, it will warn you, and then you can try again. If you need a shift key in the sequence, use the left shift key, as the right shift key is used to detect the end of the entry.

When you press the Right-SHIFT key to end the entry, the initial configuration prompt will appear:

[B] Buttons [D] Default [A] Address [C] Config [Q] Quit

You can now program another button, re-program the button you just programmed, or quit(Q) and try out the new button settings.

If you selected the Alternating (A) button programming, the following prompt will appear:

1st, Press key(s), end with Right-SHIFT key:

Type keys to assign to button, noting that you can only have about 10 keys total, or if evenly divided, 5 keys per alternate button action. When you end the first set of keys with the Right-SHIFT, then the next prompt will be:

1st, Press key(s), end with Right-SHIFT key:

When you press the Right-SHIFT key to end the entry, the initial setup prompt will appear:

[B] Buttons [D] Default [A] Address [C] Config [Q] Quit

You can now program another button, re-program the button you just programmed, or quit(Q) and try out the new button settings.

[A] Transmitter Address

The address set in the KeyRF receiver has to match the address in the transmitter. The factory receiver setting is C0000000, where “C” signifies where a jumper is installed, and “O” where a jumper is NOT installed

If “A” is pressed in response to the initial setup prompt, the following prompt will appear:

Address: [C0000000]:

If you respond with only an <ENTER>, then it will keep the current setting. Make sure you type 8 O's or C's.

To change the transmitter address, remove the small cover, prying with a fingernail or a small screwdriver (like ones used for eyeglasses). Orient the transmitter with key chain hole at the bottom. Place jumper in a position that matches the “C” in the address loaded into the receiver.

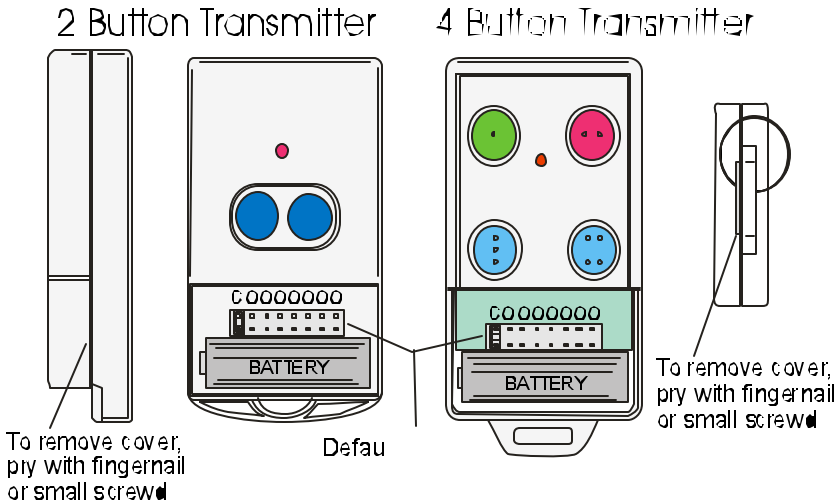

Changing Transmitter Battery

Both transmitters has a 12-volt A23 type battery. Make sure that battery plus (+) terminal matches diagram on bottom of case.

[D] Restore Setup to Factory Settings

If the settings get messed up, a recommended procedure is to restore the factory setup. Pressing “D” at the initial setup prompt will restore all settings to factory default. First you have to say which type of transmitter that you have:

[2] 2-Button [4] 4-Button

Once selected, the following settings are loaded:

2 Button Transmitter

Address	COOOOOOO
Left Button	SPACE
Right Button	BACKSPACE
Both Buttons	Alternating Home/End
X and Y	Not initialized
Configuration	2SANR0

4 Button Transmitter

Address	COOOOOOO
Button 1	SPACE
Button 2	BACKSPACE
Button 3	Alternating Home/End
4,5,6,7,8,9,A	Not initialized
Configuration	4SANR0

[C] View/Change Receiver Configuration

This shows the current version and allows for changing the parameters of the RF receiver. Pressing C gives the prompt:

KeyRF V2.2N Config [2SANR0]

The following are the configuration string definitions:

2-Bu

2SANR0

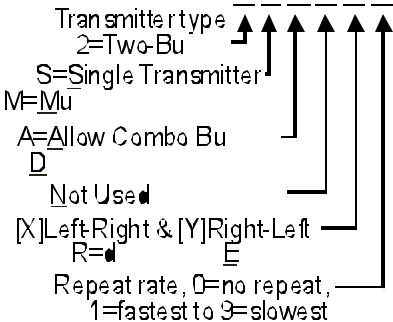

4-Bu

4SANR0

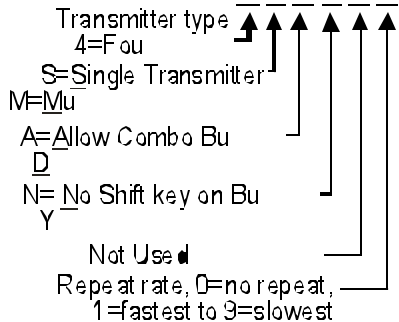

By setting and enabling the repeat rate, holding down a button will cause keys to be continuously sent to the PC. To keep the current settings, just press [ENTER]. To restore factory defaults, use the “D” command.

Disabling Combo Buttons

You can get extra remote actions from your transmitter by pressing two keys down simultaneously. This is especially useful for the four-button model. However, some people don't want this feature, and it can be disabled by changing the 3rd digit of the configuration string to a "D".

Disable two-button combo keys: 2SDNRO

Disable two-button combo keys: 4SDNRO

Two-Button Extra Button Operation

You can get two extra remote actions on your two-button transmitter by programming the "X" and "Y" buffers. These actions are triggered by pressing and holding down one button, and then pressing the other button. When you program these buttons, the 5th digit of the configuration string is automatically changed to an "E" enabling this feature. Since this changes the way the remote operates, you may want to later disable this feature by setting the 5th digit of the configuration string to an "R".

Disable Left→Right & Right→Left Operation: 2SANRO

Enabling the Four-Button Transmitter Shift Key

The 4th button on a four-button transmitter can be a shift key. This allows you to get extra programmed actions without having to press two keys at once. You press and release the shift key (button 4) and then press another button to complete the action. It's recommended that the "Combo Keys" feature be disabled when using the shift key feature. To enable this feature, change the 4th digit of the configuration string to "Y", and disable combo keys by making the 3rd digit a "D".

Enable Shift key operation: 4SDYRO

Note that to access the action assigned to button 4, you have to press the button twice. Seven button actions are accessible in this mode: 1, 2, 3, 4 then 4, 4 then 1, 4 then 2 and 4 then 3.







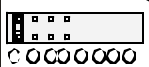
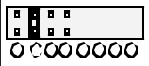
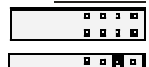

Multiple Transmitter feature

The KeyRF supports the use of multiple transmitters without any configuration changes provided that actions assigned to each button are the same. The “Multiple Transmitter” feature allows assigning a different set of actions to each transmitter. This is done by splitting the transmitter addressing block in half. Use the first 4 positions to match the address of the receiver. The second 4 positions select the beginning button buffer number in the receiver assigned to the transmitter. Using this feature you can have up to 7 two-button transmitters with unique buttons, or 3 four-button transmitters. Note that the “Combo Keys” feature is usually disabled when using this option.

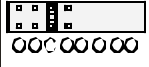
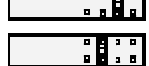
Two-Button Multi-Transmitter Option Enabled: 2MDNRO

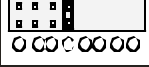
Four-Button Multi-Transmitter Option Enabled: 4MDNRO

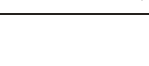
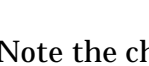
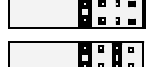
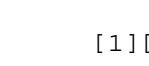
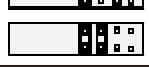
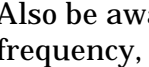
When configuring the KeyRF receiver address, always specify eight digits even though only the first four are matched to the transmitter. Below are address and buffer selection jumper examples:

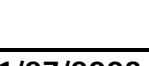
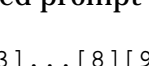
Transmitter/ Receiver Addressing	Two-Bu	Four
	# Ju Bu	# Ju Bu
	1  1 & 2	1  1,2,3&4
	2  3 & 4	2  5,6,7&8
	3  5 & 6	3  9A,B&C
	4  7 & 8	
	5  9 & A	
	6  B & C	
	7  D & E	

Note the changed prompt when programming buttons:

[1][2][3]...[8][9][A][B]...[E][F]

Also be aware that all transmitters operate under the same frequency, and true simultaneous operation is not supported.

Repeating Buttons

The KeyRF comes with buttons configured not to repeat. For most applications this should be the preferred setting. To enable repeating actions, load the 6th digit of the configuration string with a number between 1 and 9, the larger the number, the faster the repeat rate. You probably will need to experiment with this to get the right rate for your use.

Set the Two-Button transmitter repeat rate of 4: 2SANR4

Set the Four-Button transmitter repeat rate of 4: 4SANR4

Using a PS/2 Y-Adapter

If you want to use a PS/2 Mouse with your KeyRF Remote, a PS/2 Y-Adapter (Part # CL0012) may be the solution. Also, some IBM Thinkpad computers require a Y-Adapter when connecting to external keyboard devices such as the KeyRF. Below is a sample illustration of the use of a PS/2 Y-Adapter.

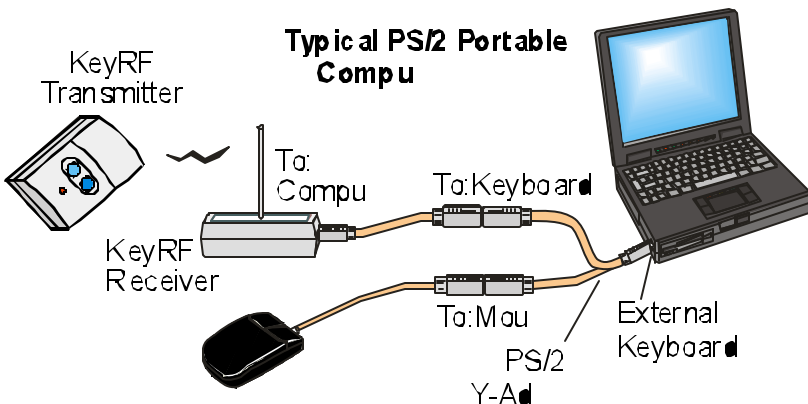

Pull out Antenna for Better Range

The antenna for the KeyRF can be extended for better reception. You can also try different placements of the KeyRF to help improve reception.



Do not discharge static electricity to antenna. Touch a grounded object first before contacting antenna. This can lock up or even damage the receiver.

KeyRF Mini-DIN Connectors

The following connector shows the pin definitions for the two 6 pin DIN connectors. The KeyRF get its 5-volt power from the PC. If a keyboard is attached, the 5-volt power is passed through to the keyboard.

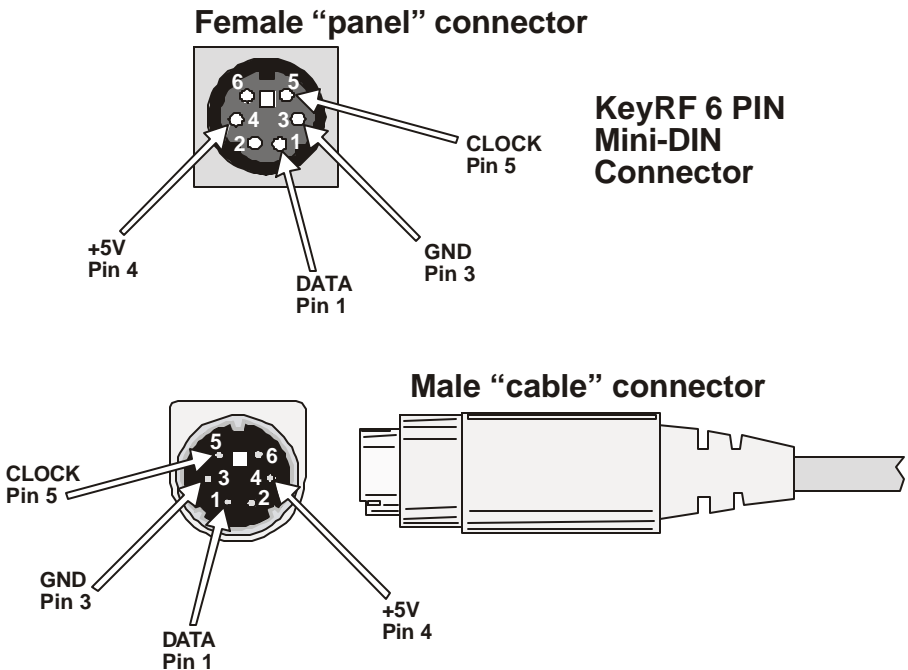

KeyRF Specifications

Dimensions: Receiver	3.65L x 2.4W x 1.5H
2 Button Transmitter	2.3L x 1.4W x .65H
4 Button Transmitter	2.5L x 1.4W x .55H
Power: Receiver	5 Volt 20ma, .1 Watt
Transmitters	12 GP23A Battery, 5ma max
Temperature	0-50°C (32-120°F)
Carrier Frequency	RF 315 MHz
Keyboard/Computer Ports	6 Pin Mini-DIN, Female
Range	100 feet
Computer-receiver interface	PS/2, Optional USB
FCC Approval	Class B

Warranty *L3 Systems guarantees this product to be free of defects in material and workmanship for 180 days from date of shipment to the end user. L3 Systems will repair or replace (at our option) products within the warranty period at no charge for parts and labor. All returns must obtain a Return of Merchandise Authorization number (RMA) available on request from L3 Systems. Shipping costs (plus customs and duty, if any) to and from L3 Systems must be paid by the user. Damage or defect caused by accident, misuse or neglect is not covered. Damage or defect caused by shipping is excluded. L3 Systems shall not be liable for any consequential damage or losses from the use of, or inability to use its products. Any unauthorized repair or modification of the product voids the warranty. L3 Systems makes no other warranty, express or implied, nor have we authorized anyone to make representations to the contrary.*

FCC Class B Approval Information

NOTE: This equipment has been tested and found to comply with the limits for a class B digital device, pursuant to part 15 of the FCC Rules. These limits are designed to provide reasonable protection against harmful interference in a residential installation. This equipment generates, uses and can radiate radio frequency energy and, if not installed and used in accordance with the instructions, may cause harmful interference to radio communications. However, there is no guarantee that interference will not occur in a particular installation. If this equipment does cause interference to radio or television reception, which determined by turning the equipment off and on, the user is encouraged to correct the interference by one or more of the following measures:

- Reorient or relocate the receiving antennae
- Increase the separation between the equipment and the receiver
- Connect the equipment into an outlet on a circuit different from that to which the receiver is connected
- Consult the dealer or an experienced radio/TV technician for help.

KeyRF – PC Remote Control

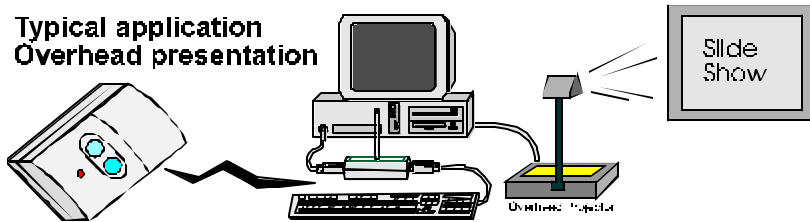

The KeyRF provides a convenient way to connect RF remote control transmitter to your PC.

APPLICATIONS

- ◆ **Overhead Presentations** - Use the KeyRF to control presentations, such as PowerPoint (© Microsoft Corp.)
- ◆ **Home Automation** - The KeyRF can provide input to your PC-based home automation applications.
- ◆ **Embedded Systems** – Many PC-based embedded systems have need of a remote control interface.
- ◆ **PC TV** – Remote control for your PC based TV.

FEATURES

- ◆ **Superior RF technology** – Receives 360° and has superior performance compared to infrared remotes.
- ◆ **Ready to Go** – Set up ready to use with presentation software. No software to load or setup required.
- ◆ **Programmable Button Actions** – Five to seven different key sequences can be sent to the PC, based on the way the buttons are pressed on the remote transmitter.
- ◆ **Easy installation** – KeyRF requires no special software to be installed on your system. Just plug the KeyRF receiver between your PC and keyboard, or your laptop's keyboard port and you are ready to go.
- ◆ **Easy to use** – KeyRF mimics your keyboard, so it will work easily with most applications.
- ◆ **6 PIN Min-DIN cable provided** – A Mini-DIN keyboard extension cable is provided, just plug it in and go.